

CONFIGURABLE MICROPROCESSOR INDICATOR CURRENT OR VOLTAGE INPUT

Description

The microprocessor-controlled panel instrument HD 9022 is an indicator with alarm thresholds that may be programmed and configured by the user. At input it accepts signals arriving from transmitters with 2 or 3 wires, in voltage 0÷1V, 0÷10V or in current 0÷20 mA, 4÷20 mA, or Pt100 with 4 wires. Configuration is always completely present in the instrument, no additional cards are required. The choice for the configuration of the input signals is made by means of the keyboard on the front of the instrument. The dimensions of the instrument are 96x48 mm with depth 145 mm in conformity with DIN 45700. The mode of operation of the HD 9022 is chosen depending on the application, configuring the instrument with the keyboard. The instrument may also be reconfigured with absolute simplicity on the field in order to adapt it to changes in processing requirements. The configuration involves the input, the scale range, the set point and the auxiliary outputs.

Applications

Typical applications are the display of signals sent by transmitters which may concern temperature, humidity, pressure, speed, capacity, level, force, etc., for the most varied industrial sectors, operating machines and automated systems.

Characteristics

- Set point configurable from -9999 to +19999.
- Indication provided by red leds with seven 1/2 inch segments.
- Separate clamp for voltage input 0÷1 / 0÷10V, current input 0÷20 / 4÷20 mA and Pt100 input (-200÷+800°C).
- The instrument has an auxiliary power supply: -5 Vdc max 10 mA and +15 Vdc non stabilized max 40 mA for the possible supply of 2-wire transmitters.
- $R_{IN} = 25 \Omega$, $R_{VIN} = 200 k\Omega$.
- Instrument accuracy: $\pm 0.1\% R_{Dg} \pm 1 \text{ Digit}$.
- A/D converter resolution: 0.05 mV/Digit, 1 μ A/Digit.
- Functions: One relay with independent exchange contact for output HI (SP1, SP2).
One relay with independent exchange contact for output LO (SP3, SP4).
One relay with maximum or minimum alarm closing contact (L max, L min.) ALARM.
Resistive relay contacts 3A/220V 50Hz.
- Instrument working temperature: (electronic componentry) 5°C÷50°C.
- Power supply: there is a terminal board for input **12÷24Vac/Vdc** or **110÷240Vac/Vdc (the one or the other; not both kinds of power supply)**.
- Instrument absorption: 5VA.
- Minimum power of the supply transformer: 20VA.

Function of the keys on the front panel, the display and the leds

- 1 Digital display. During programming the following wording appears: F0, F1, F2, F3, F4, F5, F6, F7, F8, SP1, SP2, SP3, SP4, S10.
- 2 State indicator of HI relay.
- 3 State indicator of LO relay.
- 4 State indicator of ALARM relay.
- 5 Decimal point.
- 6 PROG
- 7 ENTER
- 8 ▲
- 9 ▼



SEQUENTIAL PROGRAMMING OF WORKING PARAMETERS

- 6 **PROG** Every time this key is pressed the program moves one step forward (F0, F1, F2, F3, F4, F5, F6, F7, F8, SP1, SP2, SP3, SP4, S10).
- 7 **ENTER** When this key is pressed during programming, the value of the selected variable, which can be modified by the ▲ ▼ keys, is displayed; pressing once again **ENTER** confirms the stored value.
- 8 **▲** Pressing this key during programming increases the value indicated on the display; in F2, it moves the decimal point towards the right. In normal operation it flashes to indicate the value in Volts, mA or Pt100 corresponding to the input; with a second impulse it returns to normal operation.
- 9 **▼** Pressing this key during programming decreases the value indicated on the

Example of a connection with 2-wire transmitters; the instrument feeds the transmitter.

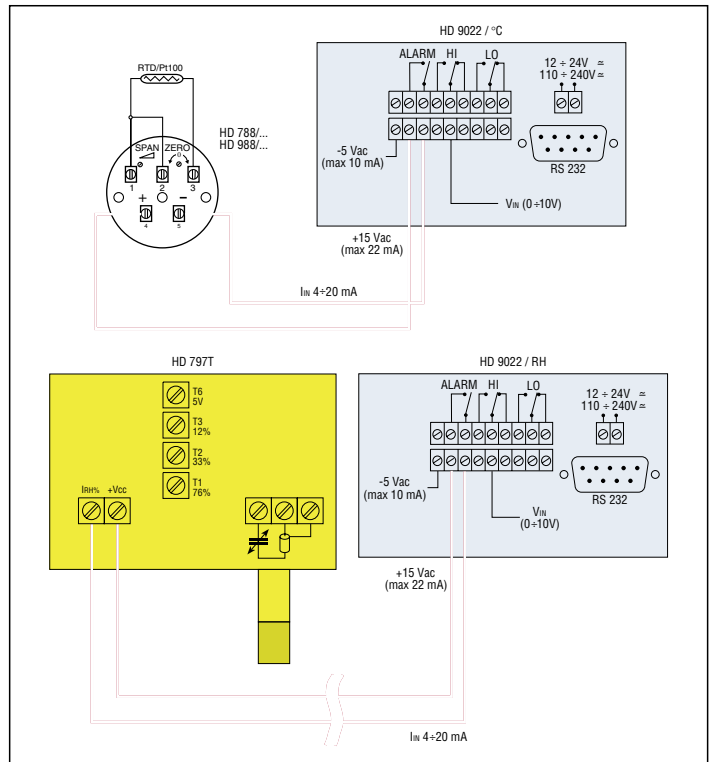

Connection examples: HD 2008T... transmitters with HD 9022 panel meter

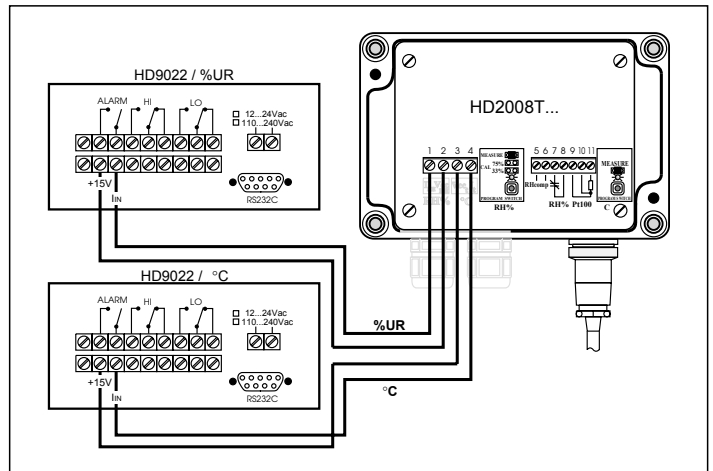

Examples of connection of the transmitter HD 2012T... with the indicator HD 9022

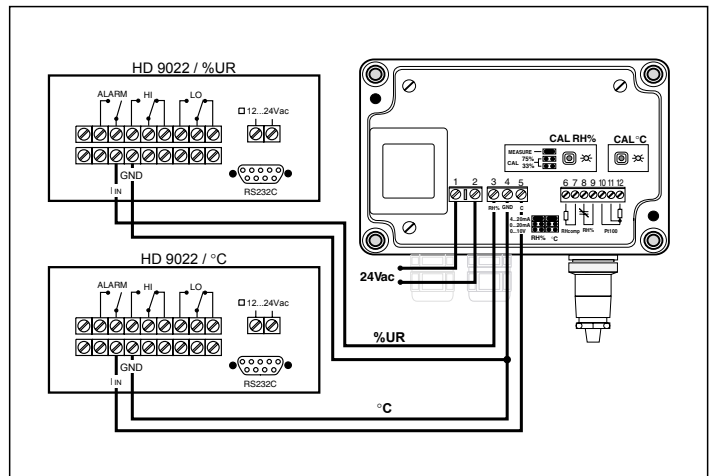

display; in F2, it moves the decimal point towards the left. In normal operation it flashes to indicate the value in Volts, mA or temperature corresponding to the input; with a second impulse it returns to normal operation.

Configuration of the HD 9022 panel indicator

- 1) Supply power to the instrument.
- 2) The instrument performs an internal check, the wording C.E.I. appears for a few seconds followed by a number at random.
- 3) Press **PROG** and the message **F0** appears.
- 4) Press **PROG** and the message **F1** appears.
- 5) Press **ENTER** and the symbol *U*, *R* or *Pt* appears. Using the **▲ ▼** buttons, choose the input for voltage: *U*, current: *R* or Pt100: *Pt* signals. Press **ENTER** to confirm.
- 6) Press **PROG** and the message **F2** appears; press **ENTER**; with the **▲ ▼** keys, set the decimal point in the desired position.

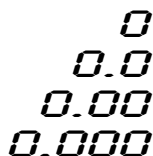

Press **ENTER** to confirm.

- 7) Press **PROG** and the message **F3** appears; press **ENTER**, with the **▲ ▼** keys, set the voltage, current or Pt100 value (as desired) corresponding to the beginning of the scale S1 for example 0V, 4 mA or 0°C. Press **ENTER** to confirm.
- 8) Press **PROG** and the message **F4** appears; press **ENTER**, with the **▲ ▼** keys, set the numerical value corresponding to the beginning of the scale R1 for example 0°C. Press **ENTER** to confirm.
- 9) Press **PROG** and the message **F5** appears; press **ENTER**, with the **▲ ▼** keys, set the voltage or current value (as selected in point 5) corresponding to the end of the scale S2 for example 10V, 20 mA or 200.0°C. Press **ENTER** to confirm.
- 10) Press **PROG** and the message **F6** appears; press **ENTER**, with the **▲ ▼** keys, set the numerical value corresponding to the end of the scale R2 for example 100°C. Press **ENTER** to confirm.
- 11) Press **PROG** and the message **F7** appears; press **ENTER**, with the **▲ ▼** keys, set the maximum alarm threshold value L max for the Alarm relay for example 110°C. Press **ENTER** to confirm.
- 12) Press **PROG** and the message **F8** appears; press **ENTER**, with the **▲ ▼** keys, set the minimum alarm threshold value L min for the Alarm relay for example -10°C. Press **ENTER** to confirm.
- 13) Press **PROG** and the message **SP1** appears; press **ENTER**, with the **▲ ▼** keys, set the Set value for the first threshold "SET relay HI" for example 40°C. Press **ENTER** to confirm.
- 14) Press **PROG** and the message **SP2** appears; press **ENTER**, with the **▲ ▼** keys, set the Reset value for the first threshold "RESET relay HI" for example 45°C. Press **ENTER** to confirm.
- 15) Press **PROG** and the message **SP3** appears; press **ENTER**, with the **▲ ▼** keys, set the Set value for the second threshold "SET relay LO" for example 50°C. Press **ENTER** to confirm.
- 16) Press **PROG** and the message **SP4** appears; press **ENTER**, with the **▲ ▼** keys, set the reset value for the second relay "RESET relay LO" for example 48°C. Press **ENTER** to confirm.
- 17) Press **PROG** and the message **S10** appears. Press **ENTER**, with the **▲ ▼** keys, set the desired speed of RS232 serial transmission among the following ones: 300, 600, 1200, 2400, 4800, 9600 baud. Press **ENTER** to confirm.
- 18) Press **PROG** and the message **F0** appears. AT THIS POINT THE CONFIGURATION OF THE INSTRUMENT IS COMPLETE.
- 19) Connect the input of the instrument, press the **ENTER** key and the display will indicate the value corresponding to the input signal.

Varying the configuration

To vary a stored parameter at any stage of the program it is sufficient to the step of the program to be changed with the **PROG** key (F1, F2, F3, etc.). Press **ENTER** and use the **▲ ▼** keys to modify the parameter previously set; press **ENTER** to confirm, return to **F0** and press **ENTER**.

This simple procedure modifies the desired step of the program.

Note

If the **ENTER**, **▲** or **▼** key is pressed independently during operation, the instrument input value (V, mA or °C) flashes on the display. To return to normal operation, press the **▲ ▼** or **ENTER** key independently again.

Error signal

The instrument indicates an error signal in the following cases:

OFL: this appears when the set value of **R max** is exceeded.

-OFL: this appears when the set value of **R min** is exceeded.

E1: this appears when the set points P1 and P2 require a resolution of the A/D converter higher than the one available.

E2: this appears when the values of F7 and F8 are inverted.

THE MAXIMUM RESOLUTION OF THE CONVERTER IS: 0.05 mV/Digit, 1µA/ Digit.

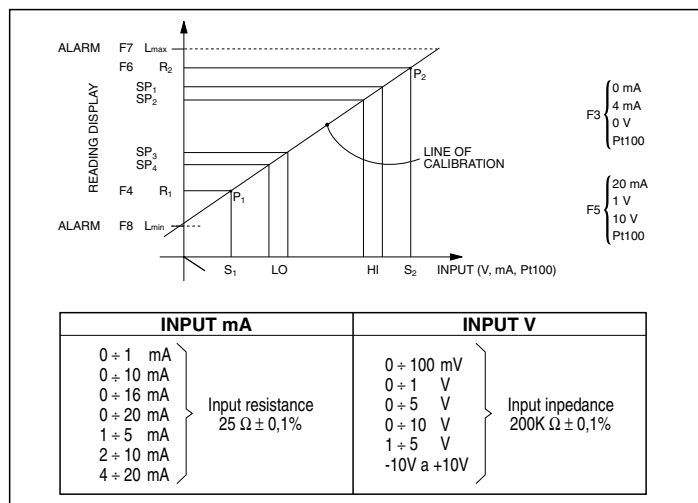

Summary of programming steps of HD 9022

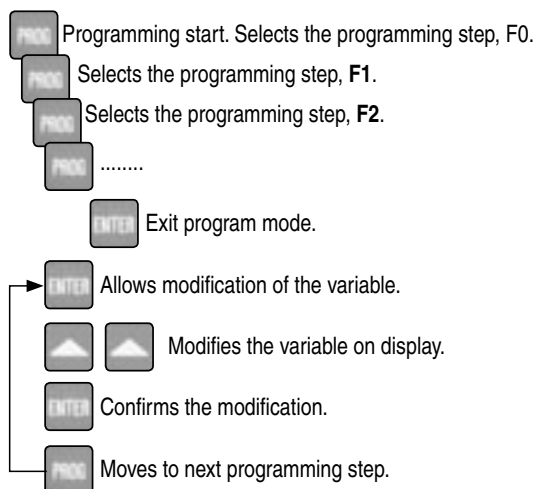

Connections

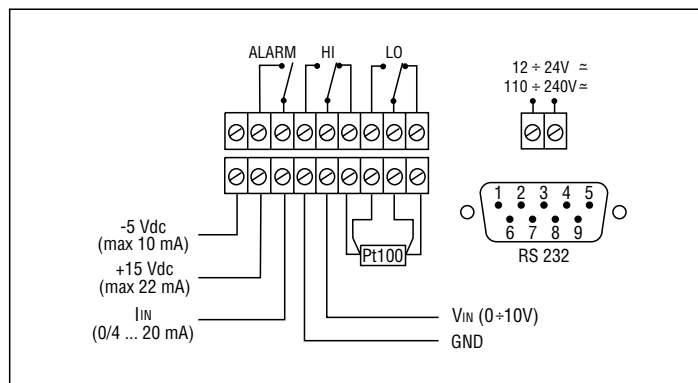

STEP	COMMENT	LIMITS
F0	Press ENTER to exit program mode	
F1	Select type of input: Voltage, current, Pt100	<i>U - R - Pt</i>
F2	Position of the decimal separator	0 - 0.0 - 0.00 - 0.000
F3	Beginning of scale value of the input (Voltage, Current, °C)	0...10,00V, 0...20,00 mA -200,0...+800,0°C
F4	Beginning of scale value of the display	-9999...19999
F5	Full scale value of the input (Voltage, Current, °C)	0...10,00V, 0...20,00 mA -200,0...+800,0°C
F6	Full scale value of the display	-9999...19999
F7	Maximum alarm threshold set point	-9999...19999
F8	Minimum alarm threshold set point	-9999...19999
SP1	ON Threshold of Set-point HI	-9999...19999
SP2	OFF Threshold of Set-point HI	-9999...19999
SP3	ON Threshold of Set-point LO	-9999...19999
SP4	OFF Threshold of set-point LO	-9999...19999
S10	Baud rate	-9999...19999 300, 600, 1200, 2400, 4800, 9600

Serial interface RS-232C

The HD 9022 is equipped with standard serial interface RS-232C which is available on the SUB D male 9-pin connector. The arrangement of the signals on this connector is as follows:

Pin	Signal	Description
2	TD	Datum transmitted by the HD 9022
3	RD	Datum received by the HD 9022
5	GND	Reference logic mass

The transmission parameters with which the instrument is supplied are:

- baud rate 9600 baud
- parity None
- n. bits 8
- stop bit 1

The data transmission speed may be changed by altering the set-up parameter S10 with the keyboard; the possible baud rates are: 9600, 4800, 2400, 1200, 600, 300. The other transmission parameters are fixed.

All the messages reaching and leaving the HD 9022 must be inserted in a "Communication frame" with the following structure:

<Stx><Record><Etx>

Where:

<Stx> Start of text (ASCII 02)
 <Record> constitutes the message
 <Etx> End of text (ASCII 03)

Host commands

The structure of the command records is as follows:

<Command character><Sub-command><Values>

Where:

- <Command character> is characterized by an alphabetic character indicating the set of commands.
- <Sub-command> is characterized by a character indicating the type of command.
- <Values> is characterized by ASCII characters that depend on the type of command.

The replies provided by the HD 9022 are essentially of two types: "Information" and "Data"

The former allow information on the status and programming of the HD 9022 to be obtained, as well as the diagnosis of the message received; the latter contain data on the two channels at the moment the request is made.

It is also possible to make use of the serial line for the complete programming of the HD 9022, with the exception of the data transmission speed which may be set only with the keyboard.

The diagnostic replies of the HD 9022 are composed of the following control characters, sent individually (not inserted in the communication frame):

- ack- Command executed (ASCII 06)
- nak- Incorrect command (ASCII 15H)

COMMAND A

Sub-command	Values	Replies
A Type of terminal	HD 9022	ack/nak
C Company	DELTA OHM	ack/nak
D Firmware Version	Vxx Rxx	ack/nak
E Firmware Date	dd/mm/yy	ack/nak
F Serial Number (rd)	xxxxxx	ack/nak
(wr)	stxAFxxxxxetx	ack/nak

COMMAND M

Sub-command	Values	Replies
1	Measure Channel 1	ack/nak
2	Measure Channel 2	ack/nak

RESET COMMAND

(wr)	Values	Replies
	stxRESEttx	ack/nak

CHANNEL 1

Sub-command	Input in	V/A/Pt	Replies
C1F01 x	Point	0/1/2/3	ack/nak
C1F02 x	Point	0/1/2/3	ack/nak
C1F03 xxxx	Start of scale	-9999...19999	ack/nak
C1F04 xxxx	V/I Start of scale	0000...10000 (2000 if I)	ack/nak
C1F05 xxxx	End of scale	-9999...19999	ack/nak
C1F06 xxxx	V/I End of scale	0000...10000 (2000 if I)	ack/nak
C1F07 xxxx	Energ. Relay HI	-9999...19999	ack/nak
C1F08 xxxx	De-energ. Relay HI	-9999...19999	ack/nak
C1F09 xxxx	Energ. Relay LO	-9999...19999	ack/nak
C1F10 xxxx	De-energ. Relay LO	-9999...19999	ack/nak
C1F11 xxxx	Min Relay Alarm	-9999...19999	ack/nak
C1F12 xxxx	Max Relay Alarm	-9999...19999	ack/nak

As regards the command just described, a few remarks must be made:

- There is no command character.
- For the other controls of the type C1F01 etc., the present programming status is supplied for the specific command if only the sequence of the sub-command characters is sent.

Ex: StxC1F01Etx Request from Host
 StxC1F01:1Etx Reply

If the sequence of the sub-command characters is followed by a space and then the desired programming value, the programming of the parameter is produced.

Ex: StxC1F01 1Etx Command from Host
 ack / nak Reply
 StxC1F03 1000Etx Command from Host
 ack / nak Reply
 StxC1F03-2000Etx Command from Host
 ack / nak Reply
 StxC1F0512000Etx Command from Host
 ack / nak Reply

Note: for programming of the point F03...F12, the value field has fixed length of 5 characters. The first character in the value field may be a space, the minus sign, or the number 1.

Connection examples with HD 9022 controller and panel meters

